

High-Voltage Transistor Arrays

The CA3146A, CA3146, CA3183A, and CA3183 are general purpose high voltage silicon NPN transistor arrays on a common monolithic substrate.

Types CA3146A and CA3146 consist of five transistors with two of the transistors connected to form a differentially connected pair. These types are recommended for low power applications in the DC through VHF range. (CA3146A and CA3146 are high voltage versions of the popular predecessor type CA3046.)

Types CA3183A and CA3183 consist of five high current transistors with independent connections for each transistor. In addition two of these transistors (Q_1 and Q_2) are matched at low current (i.e., 1mA) for applications where offset parameters are of special importance. A special substrate terminal is also included for greater flexibility in circuit design. (CA3183A and CA3183 are high voltage versions of the popular predecessor type CA3083.)

The types with an "A" suffix are premium versions of their non-"A" counterparts and feature tighter control of breakdown voltages making them more suitable for higher voltage applications.

For detailed application information, see companion Application Note AN5296 "Application of the CA3018 Integrated Circuit Transistor Array."

Ordering Information

PART NUMBER (BRAND)	TEMP. RANGE (°C)	PACKAGE	PKG. NO.
CA3146AE	-40 to 85	14 Ld PDIP	E14.3
CA3146AM (3146A)	-40 to 85	14 Ld SOIC	M14.15
CA3146E	-40 to 85	14 Ld PDIP	E14.3
CA3146M (3146)	-40 to 85	14 Ld SOIC	M14.15
CA3146M96 (3146)	-40 to 85	14 Ld SOIC Tape and Reel	M14.15
CA3183AE	-40 to 85	16 Ld PDIP	E16.3
CA3183AM96 (3183A)	-40 to 85	16 Ld SOIC Tape and Reel	M16.15
CA3183E	-40 to 85	16 Ld PDIP	E16.3
CA3183M (3183)	-40 to 85	16 Ld SOIC	M16.15
CA3183M96 (3183)	-40 to 85	16 Ld SOIC Tape and Reel	M16.15

Features

- Matched General Purpose Transistors
 - V_{BE} Match $\pm 5\text{mV}$ (Max)
- Operation from DC to 120MHz (CA3146, CA3146A)
- Low Noise Figure 3.2dB (CA3146, CA3146A)
- High I_C 75mA (Max) (CA3183, CA3183A)

Applications

- General Use in Signal Processing Systems in DC through VHF Range
- Custom Designed Differential Amplifiers
- Temperature Compensated Amplifiers
- Lamp and Relay Drivers (CA3183, CA3183A)
- Thyristor Firing (CA3183, CA3183A)

Pinouts

CA3146, CA3146A (PDIP, SOIC)
TOP VIEW

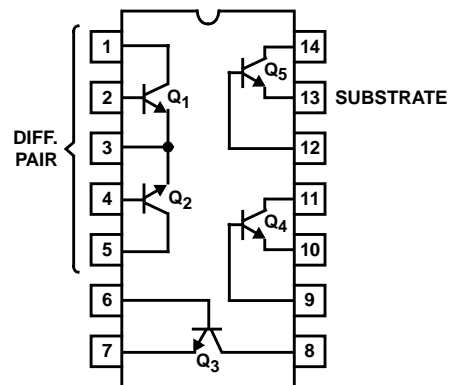

CA3183, CA3183A (PDIP, SOIC)
TOP VIEW

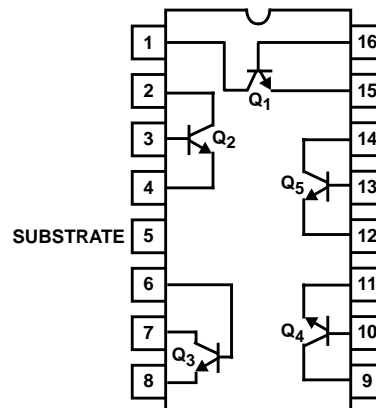

CA3146, CA3146A, CA3183, CA3183A

Absolute Maximum Ratings

Collector-to-Emitter Voltage (V_{CEO})	
CA3146A, CA3183A	40V
CA3146, CA3183	30V
Collector-to-Base Voltage (V_{CBO})	
CA3146A, CA3183A	50V
CA3146, CA3183	40V
Collector-to-Substrate Voltage (V_{CIO} , Note 1)	
CA3146A, CA3183A	50V
CA3146, CA3183	40V
Emitter to Base Voltage (V_{EBO}) all types	5V
Collector Current	
CA3146A, CA3146	50mA
CA3183A, CA3183	75mA
Base Current (I_B) - CA3183A, CA3183	20mA

Thermal Information

Thermal Resistance (Typical, Note 2)	θ_{JA} ($^{\circ}C/W$)
14 Ld PDIP Package	100
14 Ld SOIC Package	200
16 Ld PDIP Package	95
16 Ld SOIC Package	175
Maximum Power Dissipation (Any One Transistor, Note 3)	
CA3146A, CA3146	300mW
CA3183A, CA3183	500mW
Maximum Junction Temperature (Die)	175 $^{\circ}C$
Maximum Junction Temperature (Plastic Package)	150 $^{\circ}C$
Maximum Storage Temperature Range (all types)	-65 $^{\circ}C$ to 150 $^{\circ}C$
Maximum Lead Temperature (Soldering 10s)	300 $^{\circ}C$
(SOIC - Lead Tips Only)	

Operating Conditions

Temperature Range -40 $^{\circ}C$ to 85 $^{\circ}C$

CAUTION: Stresses above those listed in "Absolute Maximum Ratings" may cause permanent damage to the device. This is a stress only rating and operation of the device at these or any other conditions above those indicated in the operational sections of this specification is not implied.

NOTES:

- The collector of each transistor is isolated from the substrate by an integral diode. The substrate must be connected to a voltage which is more negative than any collector voltage in order to maintain isolation between transistors, and to provide for normal transistor action. To avoid undesired coupling between transistors, the substrate terminal should be maintained at either DC or signal (AC) ground. A suitable bypass capacitor can be used to establish a signal ground.
- θ_{JA} is measured with the component mounted on an evaluation PC board in free air.
- Care must be taken to avoid exceeding the maximum junction temperature. Use the total power dissipation (all transistors) and thermal resistances to calculate the junction temperature.

Electrical Specifications CA3146 Series

PARAMETER	SYMBOL	TEST CONDITIONS	TYPICAL PERF. CURVE FIG. NO.	CA3146			CA3146A			UNITS
		$T_A = 25^{\circ}C$		MN	TYP	MAX	MIN	TYP	MAX	
DC CHARACTERISTICS FOR EACH TRANSISTOR										
Collector-to-Base Breakdown Voltage	$V_{(BR)CBO}$	$I_C = 10\mu A, I_E = 0$	-	40	72	-	50	72	-	V
Collector-to-Emitter Breakdown Voltage	$V_{(BR)CEO}$	$I_C = 1mA, I_B = 0$	-	30	56	-	40	56	-	V
Collector-to-Substrate Breakdown Voltage	$V_{(BR)CIO}$	$I_{CI} = 10\mu A, I_B = 0, I_E = 0$	-	40	72	-	50	72	-	V
Emitter-to-Base Breakdown Voltage	$V_{(BR)EBO}$	$I_E = 10\mu A, I_C = 0$	-	5	7	-	5	7	-	V
Collector-Cutoff Current	I_{CEO}	$V_{CE} = 10V, I_B = 0$	1	-	See Curve	5	-	See Curve	5	μA
Collector-Cutoff Current	I_{CBO}	$V_{CB} = 10V, I_E = 0$	2	-	0.002	100	-	0.002	100	nA
DC Forward-Current Transfer Ratio	h_{FE}	$V_{CE} = 5V, I_C = 10mA$	3	-	85	-	-	85	-	-
		$V_{CE} = 5V, I_C = 1mA$	3	30	100	-	30	100	-	-
		$V_{CE} = 5V, I_C = 10\mu A$	3	-	90	-	-	90	-	-
Base-to-Emitter Voltage	V_{BE}	$V_{CE} = 3V, I_C = 1mA$	4	0.63	0.73	0.83	0.63	0.73	0.83	V
Collector-to-Emitter Saturation Voltage	$V_{CE SAT}$	$I_C = 10mA, I_B = 1mA$	5	-	0.33	-	-	0.33	-	V
DC CHARACTERISTICS FOR TRANSISTORS Q₁ AND Q₂ (As A Differential Amplifier)										
Magnitude of Input Offset Voltage $ V_{BE1} - V_{BE2} $	$ V_{IO} $	$V_{CE} = 5V, I_E = 1mA$	6, 7	-	0.48	5	-	0.48	5	mV
Magnitude of Base-to-Emitter Temperature Coefficient	$\left \frac{\Delta V_{BE}}{\Delta T} \right $	$V_{CE} = 5V, I_E = 1mA$	-	-	1.9	-	-	1.9	-	mV/ $^{\circ}C$

CA3146, CA3146A, CA3183, CA3183A

Electrical Specifications CA3146 Series (Continued)

PARAMETER	SYMBOL	TEST CONDITIONS	TYPICAL PERF. CURVE FIG. NO.	CA3146			CA3146A			UNITS
		T _A = 25°C		MIN	TYP	MAX	MIN	TYP	MAX	
Magnitude of V _{IO} (V _{BE1} - V _{BE2}) Temperature Coefficient	$\left \frac{\Delta V_{IO}}{\Delta T} \right $	V _{CE} = 5V, I _{C1} = I _{C2} = 1mA	-	-	1.1	-	-	1.1	-	μV/°C
Magnitude of Input Offset Current I _{IO1} - I _{IO2} (CA3146AE and CA3146E Only)	I _{IO}	V _{CE} = 5V, I _{C1} = I _{C2} = 1mA	8	-	0.3	2	-	0.3	2	μA
DYNAMIC CHARACTERISTICS										
Low Frequency Noise Figure	NF	f = 1kHz, V _{CE} = 5V, I _C = 100μA, Source Resistance = 1kΩ	10	-	3.25	-	-	3.25	-	dB
Low-Frequency, Small-Signal Equivalent-Circuit Characteristics:										
Forward-Current Transfer Ratio	h _{FE}	f = 1kHz, V _{CE} = 5V, I _C = 1mA	12	-	100	-	-	100	-	-
Short-Circuit Input Impedance	h _{IE}	f = 1kHz, V _{CE} = 5V, I _C = 1mA	12	-	3.5	-	-	2.7	-	kΩ
Open-Circuit Output Impedance	h _{OE}	f = 1kHz, V _{CE} = 5V, I _C = 1mA	12	-	15.6	-	-	15.6	-	μS
Open-Circuit Reverse Voltage Transfer Ratio	h _{RE}	f = 1kHz, V _{CE} = 5V, I _C = 1mA	12	-	1.8 x 10 ⁻⁴	-	-	1.8 x 10 ⁻⁴	-	-
Admittance Characteristics:										
Forward Transfer Admittance	Y _{FE}	f = 1MHz, V _{CE} = 5V, I _C = 1mA	13	-	31-j1.5	-	-	31-j1.5	-	mS
Input Admittance	Y _{IE}	f = 1MHz, V _{CE} = 5V, I _C = 1mA	14	-	0.3 + j0.04	-	-	0.35 + j0.04	-	mS
Output Admittance	Y _{OE}	f = 1MHz, V _{CE} = 5V, I _C = 1mA	15	-	0.001 + j0.03	-	-	0.001 + j0.03	-	mS
Reverse Transfer Admittance	Y _{RE}	f = 1MHz, V _{CE} = 5V, I _C = 1mA	16	-	See Curve	-	-	See Curve	-	mS
Gain-Bandwidth Product	f _T	V _{CE} = 5V, I _C = 3mA	17	300	500	-	300	500	-	MHz
Emitter-to-Base Capacitance	C _{EB}	V _{EB} = 5V, I _E = 0	18	-	0.70	-	-	0.70	-	pF
Collector-to-Base Capacitance	C _{CB}	V _{CB} = 5V, I _C = 0	18	-	0.37	-	-	0.37	-	pF
Collector-to-Substrate Capacitance	C _{CI}	V _{CI} = 5V, I _C = 0	18	-	2.2	-	-	2.2	-	pF

Electrical Specifications CA3183 Series

PARAMETER	SYMBOL	TEST CONDITIONS	TYPICAL PERF. CURVE FIG. NO.	CA3183			CA3183A			UNITS
		T _A = 25°C		MIN	TYP	MAX	MIN	TYP	MAX	
DC CHARACTERISTICS FOR EACH TRANSISTOR										
Collector-to-Base Breakdown Voltage	V _{(BR)CBO}	I _C = 100μA, I _E = 0	-	40	-	-	50	-	-	V
Collector-to-Emitter Breakdown Voltage	V _{(BR)CEO}	I _C = 1mA, I _B = 0	-	30	-	-	40	-	-	V
Collector-to-Substrate Breakdown Voltage	V _{(BR)CIO}	I _{CI} = 100μA, I _B = 0, I _E = 0	-	40	-	-	50	-	-	V
Emitter-to-Base Breakdown Voltage	V _{(BR)EBO}	I _E = 500μA, I _C = 0	-	5	-	-	5	-	-	V
Collector-Cutoff Current	I _{CEO}	V _{CE} = 10V, I _B = 0	19	-	-	10	-	-	10	μA

CA3146, CA3146A, CA3183, CA3183A

Electrical Specifications CA3183 Series (Continued)

PARAMETER	SYMBOL	TEST CONDITIONS	TYPICAL PERFORM. CURVE FIG. NO.	CA3183			CA3183A			UNITS
		$T_A = 25^\circ\text{C}$		MIN	TYP	MAX	MIN	TYP	MAX	
Collector-Cutoff Current	I_{CBO}	$V_{CB} = 10\text{V}, I_E = 0$	20	-	-	1	-	-	1	μA
DC Forward-Current Transfer Ratio	h_{FE}	$V_{CE} = 3\text{V}, I_C = 10\text{mA}$	21, 22	40	-	-	40	-	-	-
		$V_{CE} = 5\text{V}, I_C = 50\text{mA}$	-	40	-	-	40	-	-	-
Base-to-Emitter Voltage	V_{BE}	$V_{CE} = 3\text{V}, I_C = 10\text{mA}$	23	0.65	0.75	0.85	0.65	0.75	0.85	V
Collector-to-Emitter Saturation Voltage	$V_{CE\text{ SAT}}$ (Note 3)	$I_C = 50\text{mA}, I_B = 5\text{mA}$	24	-	1.7	3.0	-	1.7	3.0	V
FOR TRANSISTORS Q₁ AND Q₂ (AS A DIFFERENTIAL AMPLIFIER)										
Absolute Input Offset Voltage	$ V_{IO} $	$V_{CE} = 3\text{V}, I_C = 1\text{mA}$	25	-	0.47	5	-	0.47	5	mV
Absolute Input Offset Current	$ I_{IO} $	$V_{CE} = 3\text{V}, I_C = 1\text{mA}$	26	-	0.78	2.5	-	0.78	2.5	μA

Typical Performance Curves DC Characteristics - CA3146 Series

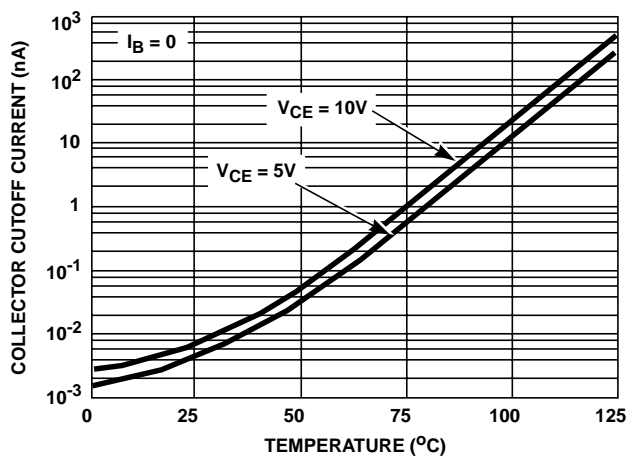

FIGURE 1. I_{CEO} vs TEMPERATURE FOR ANY TRANSISTOR

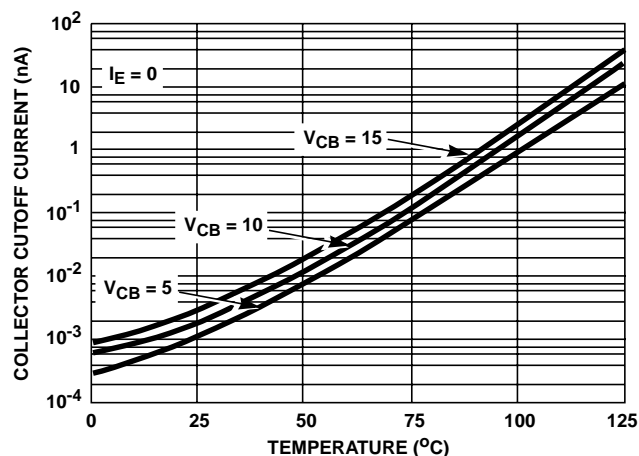

FIGURE 2. I_{CBO} vs TEMPERATURE FOR ANY TRANSISTOR

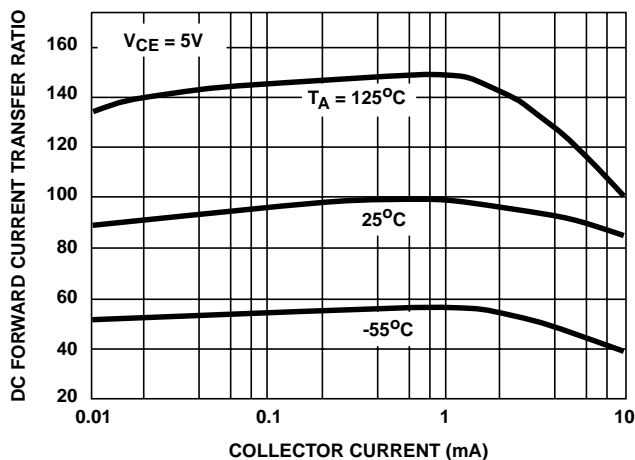

FIGURE 3. h_{FE} vs I_C FOR ANY TRANSISTOR

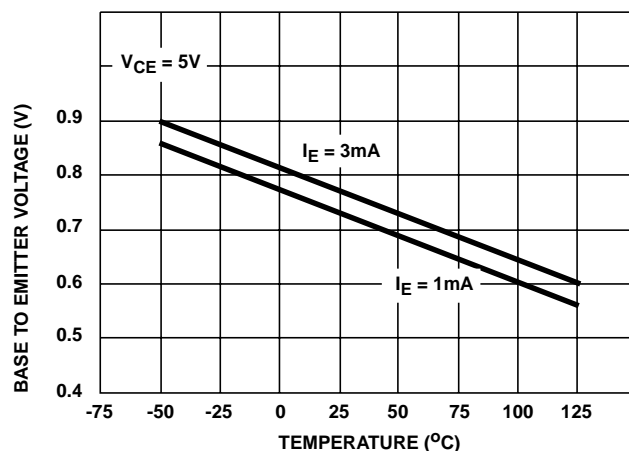

FIGURE 4. V_{BE} vs TEMPERATURE FOR ANY TRANSISTOR

Typical Performance Curves DC Characteristics - CA3146 Series (Continued)

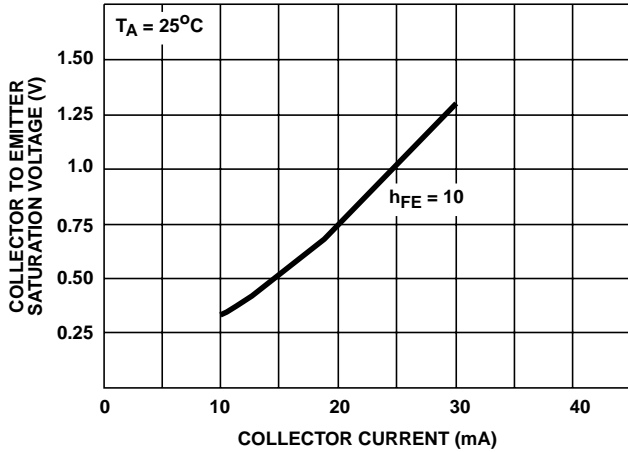

FIGURE 5. $V_{CE SAT}$ vs I_C FOR ANY TRANSISTOR

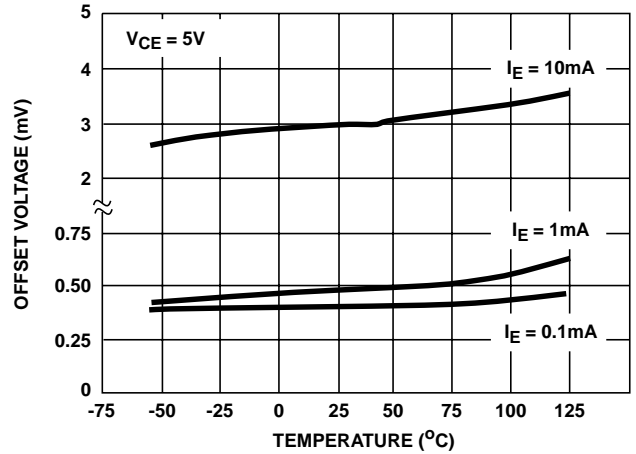

FIGURE 6. V_{IO} vs TEMPERATURE FOR Q_1 AND Q_2

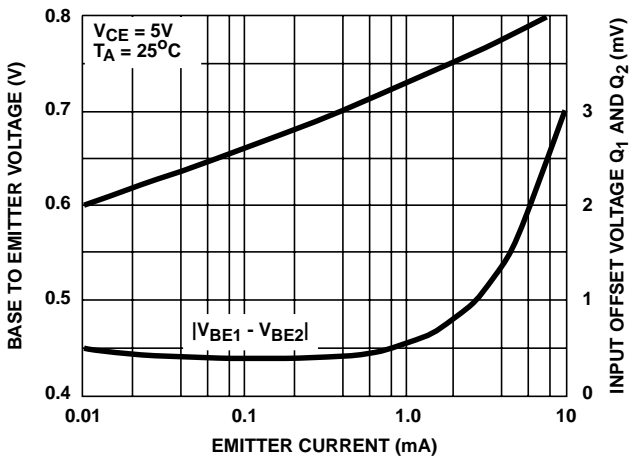

FIGURE 7. V_{BE} AND V_{IO} vs I_E FOR Q_1 AND Q_2

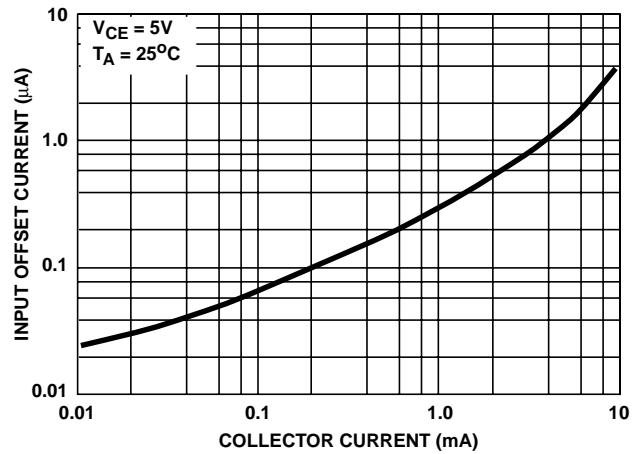

FIGURE 8. I_{IO} vs I_C FOR Q_1 AND Q_2

Typical Performance Curves Dynamic Characteristics (For Any Transistor) - CA3146 Series

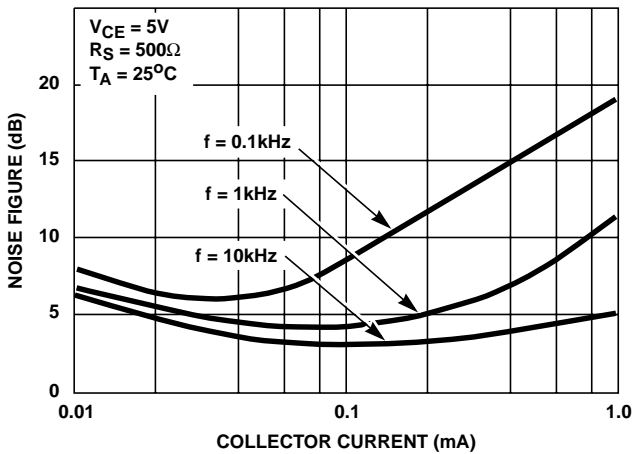

FIGURE 9. NF vs I_C AT $R_S = 500\Omega$

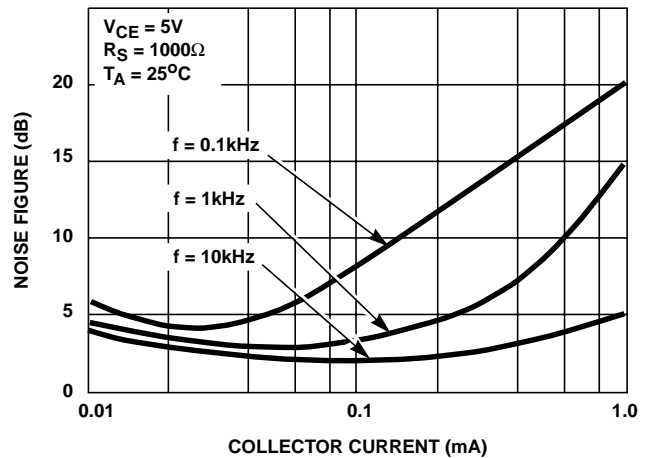

FIGURE 10. NF vs I_C AT $R_S = 1k\Omega$

Typical Performance Curves Dynamic Characteristics (For Any Transistor) - CA3146 Series (Continued)

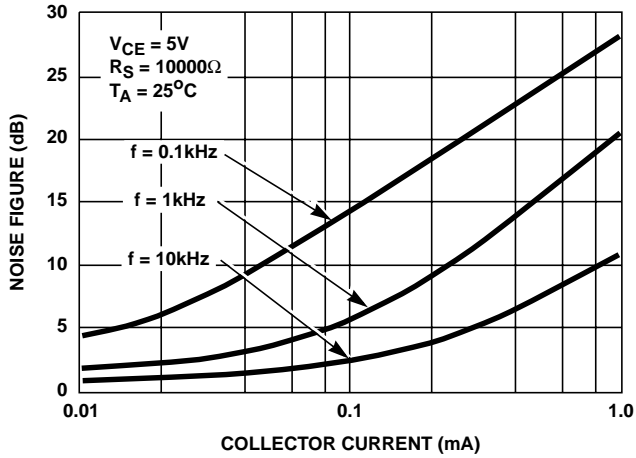

FIGURE 11. NF vs I_C AT $R_S = 10k\Omega$

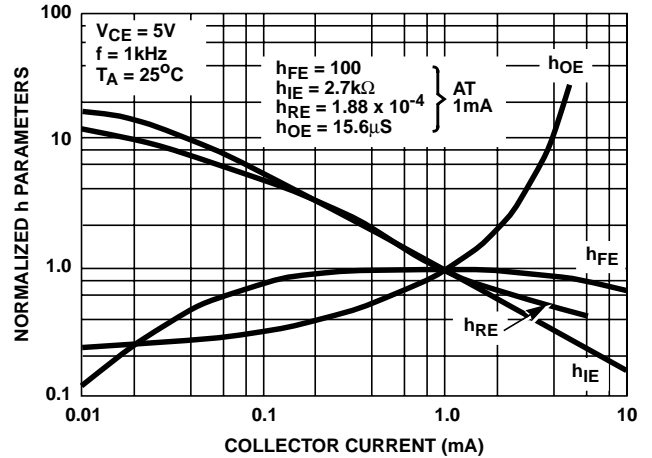

FIGURE 12. h_{FE} , h_{IE} , h_{OE} , h_{RE} vs I_C

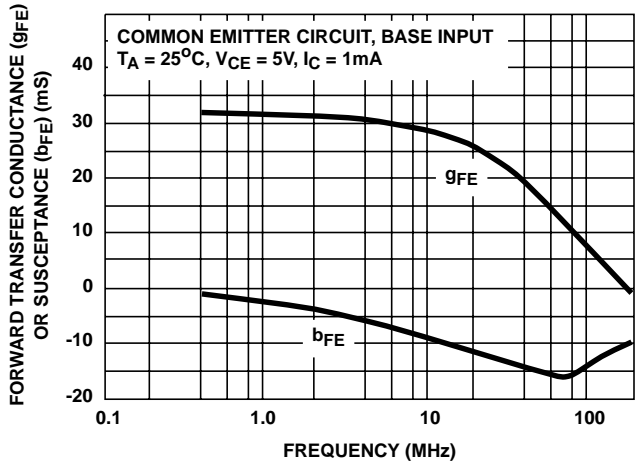

FIGURE 13. y_{FE} vs FREQUENCY

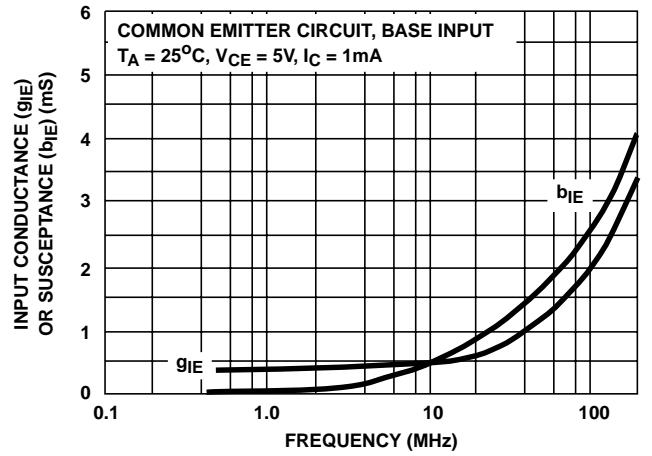

FIGURE 14. y_{IE} vs FREQUENCY

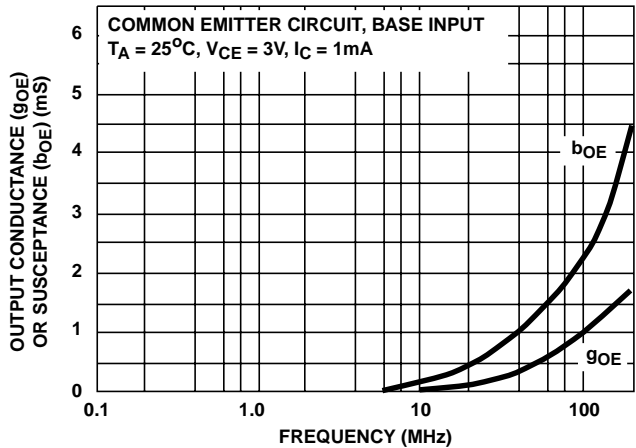

FIGURE 15. y_{OE} vs FREQUENCY

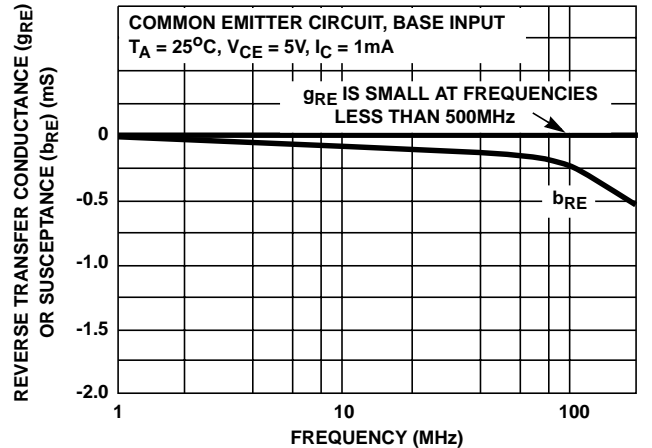

FIGURE 16. y_{RE} vs FREQUENCY

Typical Performance Curves Dynamic Characteristics (For Any Transistor) - CA3146 Series (Continued)

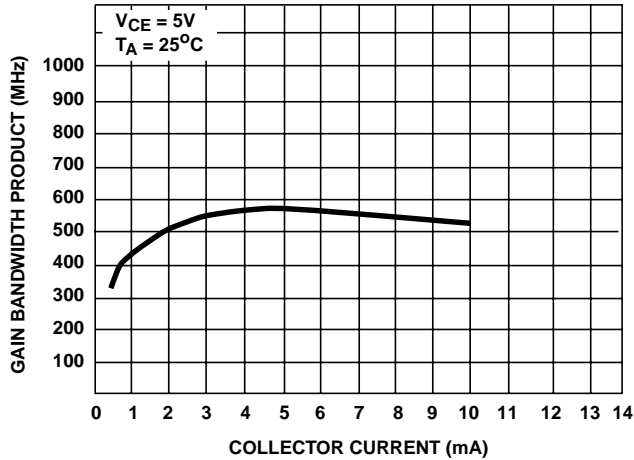

FIGURE 17. f_T vs I_C

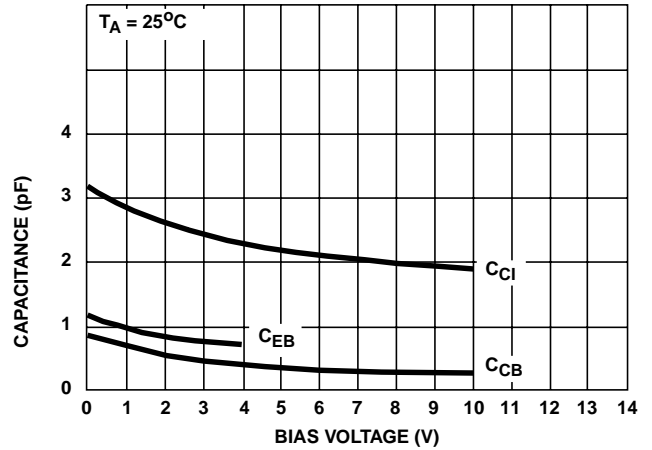

FIGURE 18. C_{EB} , C_{CB} , C_{CI} vs BIAS VOLTAGE

Typical Performance Curves DC Characteristics - CA3183 Series

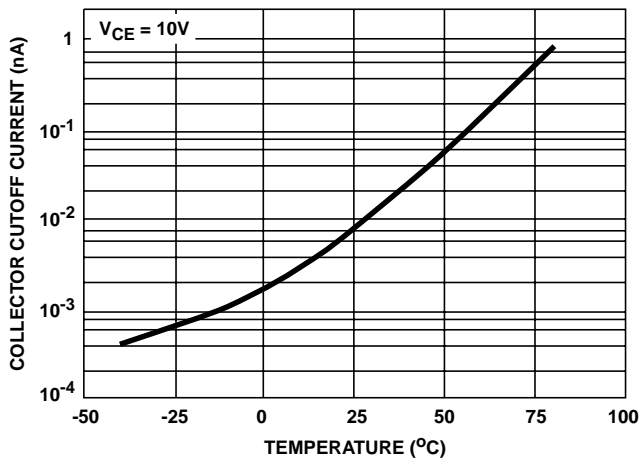

FIGURE 19. I_{CEO} vs TEMPERATURE FOR ANY TRANSISTOR

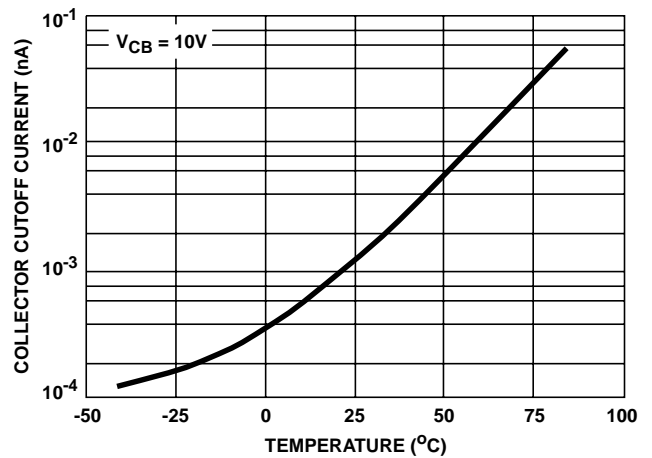

FIGURE 20. I_{CBO} vs TEMPERATURE FOR ANY TRANSISTOR

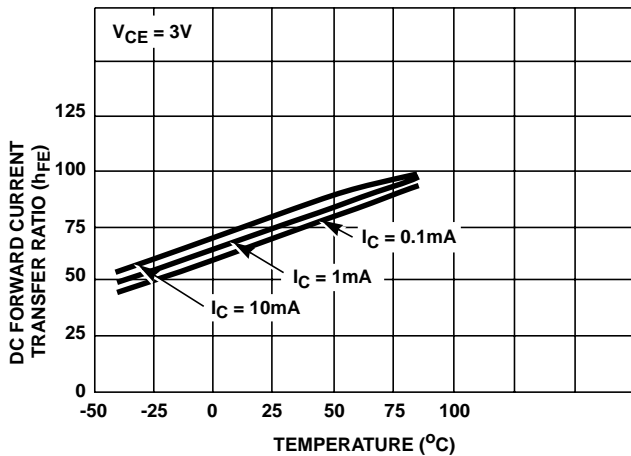

FIGURE 21. h_{FE} vs TEMPERATURE FOR ANY TRANSISTOR

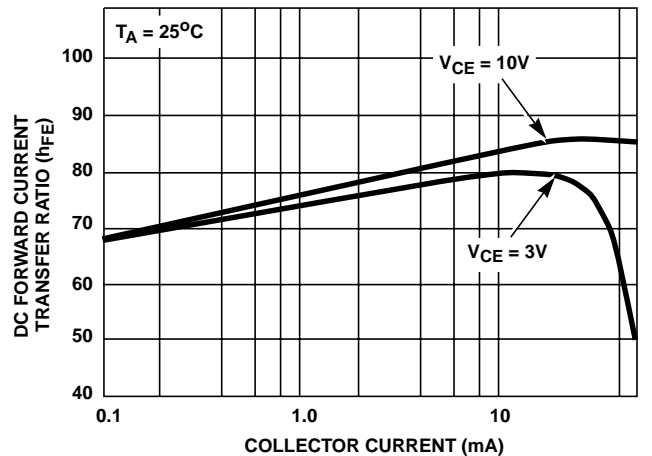

FIGURE 22. h_{FE} vs I_C FOR ANY TRANSISTOR

Typical Performance Curves DC Characteristics - CA3183 Series (Continued)

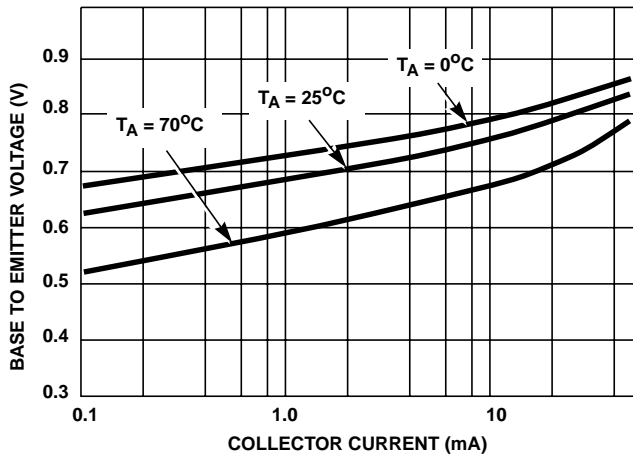

FIGURE 23. V_{BE} vs I_C FOR ANY TRANSISTOR

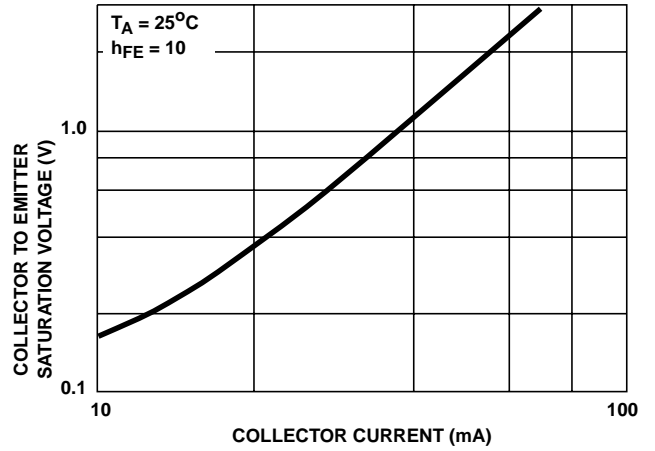

FIGURE 24. $V_{CE\text{ SAT}}$ vs I_C FOR ANY TRANSISTOR

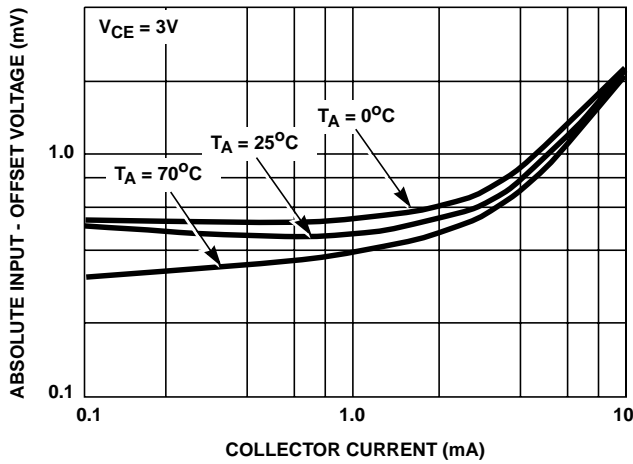

FIGURE 25. $|V_{IO}|$ vs I_C FOR DIFFERENTIAL AMPLIFIER (Q₁ AND Q₂)

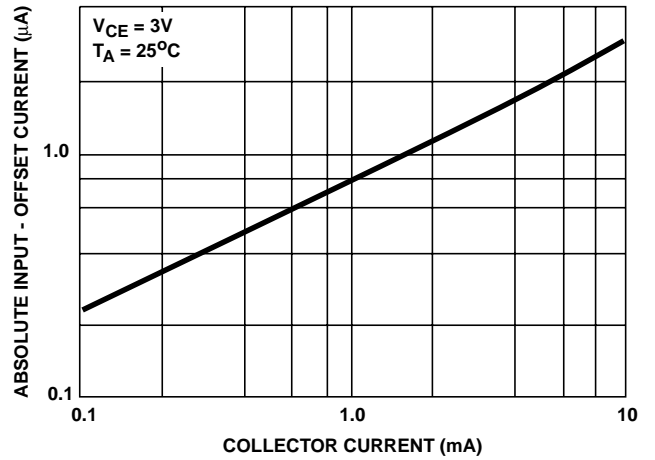
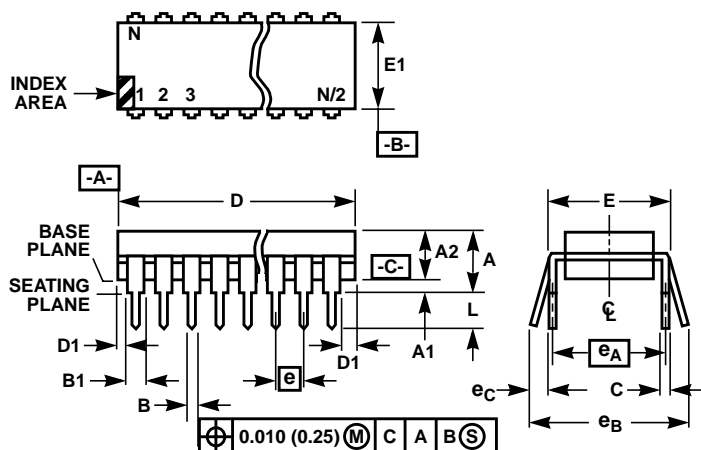

FIGURE 26. $|I_{IO}|$ vs I_C FOR DIFFERENTIAL AMPLIFIER (Q₁ AND Q₂)

Dual-In-Line Plastic Packages (PDIP)



NOTES:

- Controlling Dimensions: INCH. In case of conflict between English and Metric dimensions, the inch dimensions control.
- Dimensioning and tolerancing per ANSI Y14.5M-1982.
- Symbols are defined in the "MO Series Symbol List" in Section 2.2 of Publication No. 95.
- Dimensions A, A1 and L are measured with the package seated in JEDEC seating plane gauge GS-3.
- D, D1, and E1 dimensions do not include mold flash or protrusions. Mold flash or protrusions shall not exceed 0.010 inch (0.25mm).
- E and e_A are measured with the leads constrained to be perpendicular to datum $-C-$.
- e_B and e_C are measured at the lead tips with the leads unconstrained. e_C must be zero or greater.
- B1 maximum dimensions do not include dambar protrusions. Dambar protrusions shall not exceed 0.010 inch (0.25mm).
- N is the maximum number of terminal positions.
- Corner leads (1, N, N/2 and N/2 + 1) for E8.3, E16.3, E18.3, E28.3, E42.6 will have a B1 dimension of 0.030 - 0.045 inch (0.76 - 1.14mm).

E14.3 (JEDEC MS-001-AA ISSUE D)
14 LEAD DUAL-IN-LINE PLASTIC PACKAGE

SYMBOL	INCHES		MILLIMETERS		NOTES
	MIN	MAX	MIN	MAX	
A	-	0.210	-	5.33	4
A1	0.015	-	0.39	-	4
A2	0.115	0.195	2.93	4.95	-
B	0.014	0.022	0.356	0.558	-
B1	0.045	0.070	1.15	1.77	8
C	0.008	0.014	0.204	0.355	-
D	0.735	0.775	18.66	19.68	5
D1	0.005	-	0.13	-	5
E	0.300	0.325	7.62	8.25	6
E1	0.240	0.280	6.10	7.11	5
e	0.100 BSC		2.54 BSC		-
e_A	0.300 BSC		7.62 BSC		6
e_B	-	0.430	-	10.92	7
L	0.115	0.150	2.93	3.81	4
N	14		14		9

Rev. 0 12/93

Dual-In-Line Plastic Packages (PDIP)

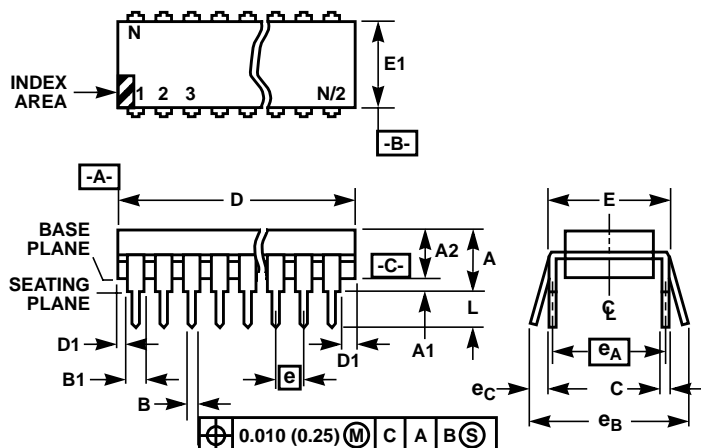

NOTES:

1. Controlling Dimensions: INCH. In case of conflict between English and Metric dimensions, the inch dimensions control.
2. Dimensioning and tolerancing per ANSI Y14.5M-1982.
3. Symbols are defined in the "MO Series Symbol List" in Section 2.2 of Publication No. 95.
4. Dimensions A, A1 and L are measured with the package seated in JEDEC seating plane gauge GS-3.
5. D, D1, and E1 dimensions do not include mold flash or protrusions. Mold flash or protrusions shall not exceed 0.010 inch (0.25mm).
6. E and e_A are measured with the leads constrained to be perpendicular to datum -C-.
7. e_B and e_C are measured at the lead tips with the leads unconstrained. e_C must be zero or greater.
8. B1 maximum dimensions do not include dambar protrusions. Dambar protrusions shall not exceed 0.010 inch (0.25mm).
9. N is the maximum number of terminal positions.
10. Corner leads (1, N, N/2 and N/2 + 1) for E8.3, E16.3, E18.3, E28.3, E42.6 will have a B1 dimension of 0.030 - 0.045 inch (0.76 - 1.14mm).

E16.3 (JEDEC MS-001-BB ISSUE D)
16 LEAD DUAL-IN-LINE PLASTIC PACKAGE

SYMBOL	INCHES		MILLIMETERS		NOTES
	MIN	MAX	MIN	MAX	
A	-	0.210	-	5.33	4
A1	0.015	-	0.39	-	4
A2	0.115	0.195	2.93	4.95	-
B	0.014	0.022	0.356	0.558	-
B1	0.045	0.070	1.15	1.77	8, 10
C	0.008	0.014	0.204	0.355	-
D	0.735	0.775	18.66	19.68	5
D1	0.005	-	0.13	-	5
E	0.300	0.325	7.62	8.25	6
E1	0.240	0.280	6.10	7.11	5
e	0.100 BSC		2.54 BSC		-
e_A	0.300 BSC		7.62 BSC		6
e_B	-	0.430	-	10.92	7
L	0.115	0.150	2.93	3.81	4
N	16		16		9

Rev. 0 12/93

Small Outline Plastic Packages (SOIC)

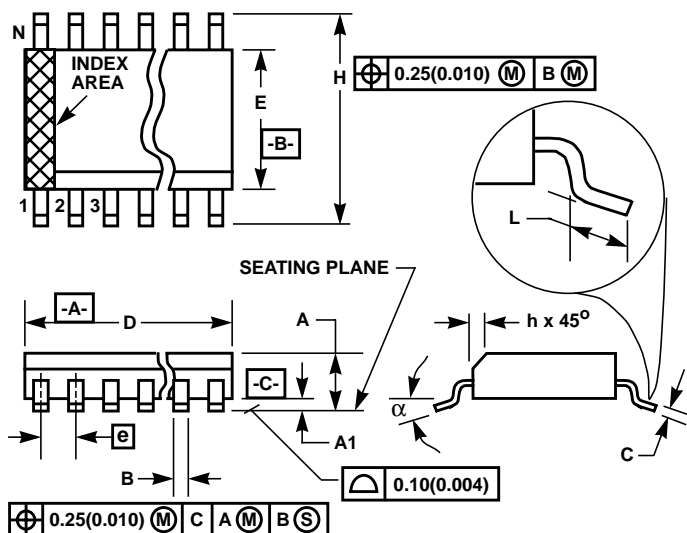

M14.15 (JEDEC MS-012-AB ISSUE C)
14 LEAD NARROW BODY SMALL OUTLINE PLASTIC PACKAGE

SYMBOL	INCHES		MILLIMETERS		NOTES
	MIN	MAX	MIN	MAX	
A	0.0532	0.0688	1.35	1.75	-
A1	0.0040	0.0098	0.10	0.25	-
B	0.013	0.020	0.33	0.51	9
C	0.0075	0.0098	0.19	0.25	-
D	0.3367	0.3444	8.55	8.75	3
E	0.1497	0.1574	3.80	4.00	4
e	0.050 BSC		1.27 BSC		-
H	0.2284	0.2440	5.80	6.20	-
h	0.0099	0.0196	0.25	0.50	5
L	0.016	0.050	0.40	1.27	6
N	14		14		7
α	0°	8°	0°	8°	-

NOTES:

1. Symbols are defined in the "MO Series Symbol List" in Section 2.2 of Publication Number 95.
2. Dimensioning and tolerancing per ANSI Y14.5M-1982.
3. Dimension "D" does not include mold flash, protrusions or gate burrs. Mold flash, protrusion and gate burrs shall not exceed 0.15mm (0.006 inch) per side.
4. Dimension "E" does not include interlead flash or protrusions. Interlead flash and protrusions shall not exceed 0.25mm (0.010 inch) per side.
5. The chamfer on the body is optional. If it is not present, a visual index feature must be located within the crosshatched area.
6. "L" is the length of terminal for soldering to a substrate.
7. "N" is the number of terminal positions.
8. Terminal numbers are shown for reference only.
9. The lead width "B", as measured 0.36mm (0.014 inch) or greater above the seating plane, shall not exceed a maximum value of 0.61mm (0.024 inch).
10. Controlling dimension: MILLIMETER. Converted inch dimensions are not necessarily exact.

Rev. 0 12/93

Small Outline Plastic Packages (SOIC)

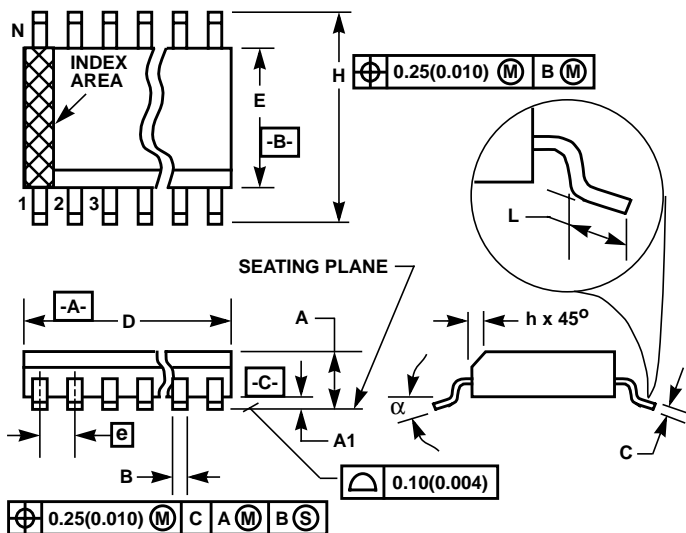

M16.15 (JEDEC MS-012-AC ISSUE C)
16 LEAD NARROW BODY SMALL OUTLINE PLASTIC PACKAGE

SYMBOL	INCHES		MILLIMETERS		NOTES
	MIN	MAX	MIN	MAX	
A	0.0532	0.0688	1.35	1.75	-
A1	0.0040	0.0098	0.10	0.25	-
B	0.013	0.020	0.33	0.51	9
C	0.0075	0.0098	0.19	0.25	-
D	0.3859	0.3937	9.80	10.00	3
E	0.1497	0.1574	3.80	4.00	4
e	0.050 BSC		1.27 BSC		-
H	0.2284	0.2440	5.80	6.20	-
h	0.0099	0.0196	0.25	0.50	5
L	0.016	0.050	0.40	1.27	6
N	16		16		7
α	0°	8°	0°	8°	-

NOTES:

1. Symbols are defined in the "MO Series Symbol List" in Section 2.2 of Publication Number 95.
2. Dimensioning and tolerancing per ANSI Y14.5M-1982.
3. Dimension "D" does not include mold flash, protrusions or gate burrs. Mold flash, protrusion and gate burrs shall not exceed 0.15mm (0.006 inch) per side.
4. Dimension "E" does not include interlead flash or protrusions. Interlead flash and protrusions shall not exceed 0.25mm (0.010 inch) per side.
5. The chamfer on the body is optional. If it is not present, a visual index feature must be located within the crosshatched area.
6. "L" is the length of terminal for soldering to a substrate.
7. "N" is the number of terminal positions.
8. Terminal numbers are shown for reference only.
9. The lead width "B", as measured 0.36mm (0.014 inch) or greater above the seating plane, shall not exceed a maximum value of 0.61mm (0.024 inch).
10. Controlling dimension: MILLIMETER. Converted inch dimensions are not necessarily exact.

Rev. 0 12/93

All Intersil semiconductor products are manufactured, assembled and tested under **ISO9000** quality systems certification.

Intersil semiconductor products are sold by description only. Intersil Corporation reserves the right to make changes in circuit design and/or specifications at any time without notice. Accordingly, the reader is cautioned to verify that data sheets are current before placing orders. Information furnished by Intersil is believed to be accurate and reliable. However, no responsibility is assumed by Intersil or its subsidiaries for its use; nor for any infringements of patents or other rights of third parties which may result from its use. No license is granted by implication or otherwise under any patent or patent rights of Intersil or its subsidiaries.

For information regarding Intersil Corporation and its products, see web site www.intersil.com

Sales Office Headquarters

NORTH AMERICA
 Intersil Corporation
 P. O. Box 883, Mail Stop 53-204
 Melbourne, FL 32902
 TEL: (321) 724-7000
 FAX: (321) 724-7240

EUROPE
 Intersil SA
 Mercure Center
 100, Rue de la Fusee
 1130 Brussels, Belgium
 TEL: (32) 2.724.2111
 FAX: (32) 2.724.22.05

ASIA
 Intersil (Taiwan) Ltd.
 7F-6, No. 101 Fu Hsing North Road
 Taipei, Taiwan
 Republic of China
 TEL: (886) 2 2716 9310
 FAX: (886) 2 2715 3029