

**TIL189-1 THRU TIL189-4  
TIL190-1 THRU TIL190-4  
OPTOCOUPLED/OPTOISOLATORS**

SOOS038A D2987, JANUARY 1987—REVISED JULY 1989

- High Direct-Current Transfer Ratios, 500% Minimum at  $I_f = 10$  mA and Up to 1500% at  $I_f = 2$  mA with Choice of Four Categories
- Plastic Dual-In-Line Package
- High-Voltage Electrical Isolation, 3.535 kV Peak (2.5 kV rms)
- Gallium Arsenide Diode Infrared Source Optically Coupled to a Silicon N-P-N Darlington Phototransistor
- No Base Lead Connection on TIL190 for High-EMI Environment
- UL Recognized — File # E65085

**description**

The TIL189 and TIL190 Optocouplers are designed for use in applications that require high current transfer ratio and high voltage isolation between the input and output. The TIL189 has the base connected for applications where a base signal or resistor is required. The TIL190 is designed with no internal base connection for applications where high base-noise immunity is desired. Users can select from four different current gains (TIL189-1 through TIL189-4 and TIL190-1 through TIL190-4).

**mechanical data**

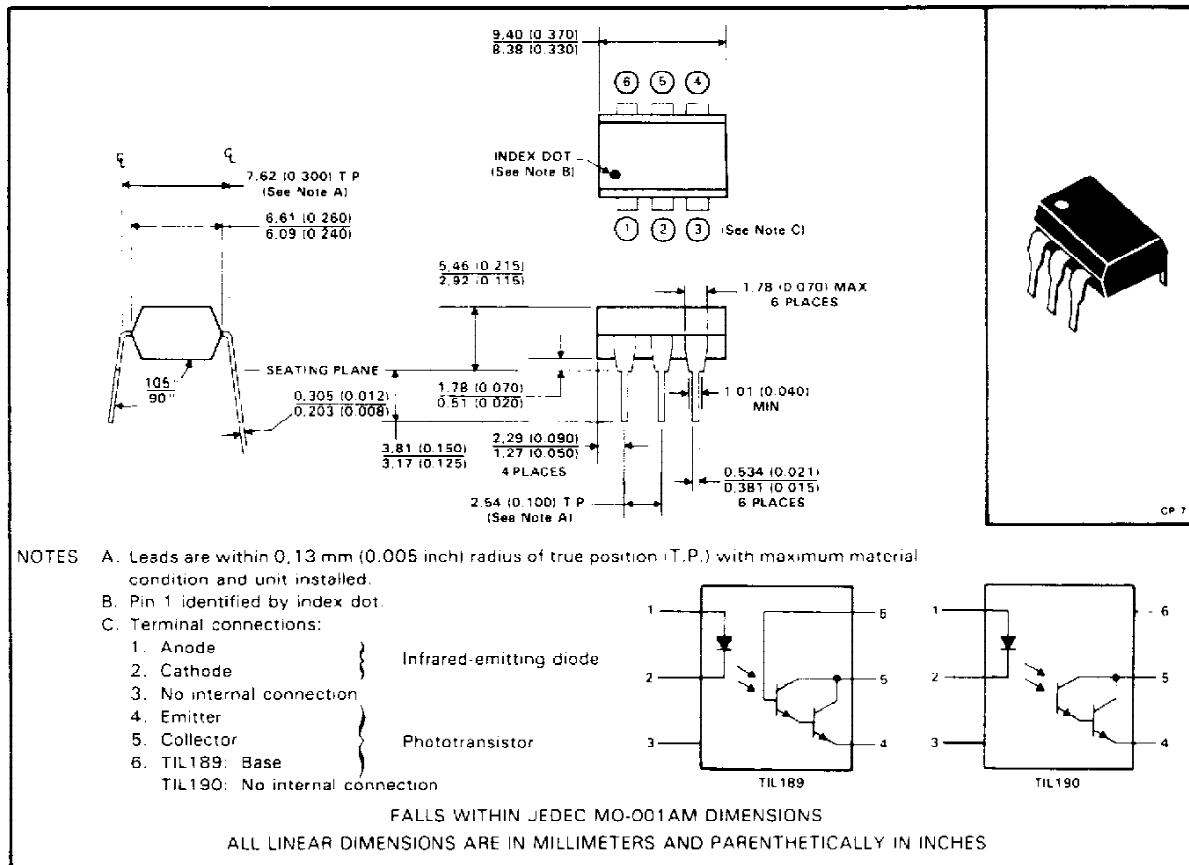

PRODUCTION DATA documents contain information current as of publication date. Products conform to specifications per the terms of Texas Instruments standard warranty. Production processing does not necessarily include testing of all parameters.

Copyright © 1989, Texas Instruments Incorporated



POST OFFICE BOX 655303 • DALLAS, TEXAS 75265

**TIL189-1 THRU TIL189-4  
TIL190-1 THRU TIL190-4  
OPTOCOUPERS/OPTOISOLATORS**

---

**absolute maximum ratings at 25°C free-air temperature (unless otherwise noted)**

Input-to-output voltage	±3.535 kV peak or dc (±2.5 kV rms)
Collector-base voltage (TIL189)	100 V
Collector-emitter voltage (see Note 1)	55 V
Emitter-collector voltage	7 V
Emitter-base voltage (TIL189)	14 V
Input diode reverse voltage	3 V
Input diode continuous forward current at (or below)	
25°C free-air temperature (see Note 2)	100 mA
Continuous power dissipation at (or below) 25°C free-air temperature:	
Infrared-emitting diode (see Note 3)	150 mW
Phototransistor (see Note 3)	150 mW
Total, infrared-emitting diode plus phototransistor (see Note 4)	250 mW
Storage temperature range	-55°C to 150°C
Lead temperature 1,6 mm (1/16-inch) from case for 10 seconds	260°C

- NOTES: 1. This value applies when the base-emitter diode is open circuited.  
 2. Derate linearly to 100°C free-air temperature at the rate of 1.33 mA/°C.  
 3. Derate linearly to 100°C free-air temperature at the rate of 2 mW/°C.  
 4. Derate linearly to 100°C free-air temperature at the rate of 3.33 mW/°C.

**TIL189-1 THRU TIL189-4**  
**TIL190-1 THRU TIL190-4**  
**OPTOCOUPERS/OPTOISOLATORS**

electrical characteristics at 25°C free-air temperature (unless otherwise noted)

PARAMETER		TEST CONDITIONS	TIL189			TIL190			UNIT		
			MIN	TYP	MAX	MIN	TYP	MAX			
$V_{(BR)CBO}$	Collector-base breakdown voltage	$I_C = 10 \mu A, I_E = 0, I_F = 0$	100						V		
$V_{(BR)CEO}$	Collector-emitter breakdown voltage	$I_C = 1 mA, I_B = 0, I_F = 0$	55			65			V		
$V_{(BR)EBO}$	Emitter-base breakdown voltage	$I_E = 10 \mu A, I_C = 0, I_F = 0$	14						V		
$V_{(BR)ECO}$	Emitter-collector breakdown voltage	$I_E = 100 \mu A, I_F = 0$				7			V		
$I_R$	Input diode static reverse current	$V_R = 3 V$				10			$\mu A$		
$I_{C(on)}$	On-state collector current	Photo-transistor operation $V_{CE} = 1 V, I_F = 2 mA, I_B = 0$	TIL189-1, TIL190-1			5			mA		
			TIL189-2, TIL190-2			10					
			TIL189-3, TIL190-3			20					
			TIL189-4, TIL190-4			30					
		$V_{CE} = 1 V, I_F = 10 mA, I_B = 0$	50			50					
	Photodiode operation	$V_{CB} = 1 V, I_F = 10 mA, I_E = 0$	5	15				$\mu A$			
$I_{C(off)}$	Off-state collector current	$V_{CE} = 10 V, I_F = 0, I_B = 0$	1			100			nA		
$h_{FE}$	Transistor static forward current transfer ratio	$V_{CE} = 1 V, I_C = 10 mA, I_F = 0$	25000								
$V_F$	Input diode static forward voltage	$I_F = 10 mA$	1.2		1.5		1.2		1.5		V
$V_{CE(sat)}$	Collector-emitter saturation voltage	$I_C = 50 mA, I_F = 10 mA, I_B = 0$	0.87		1		0.87		1		V
$r_{iD}$	Input-to-output internal resistance	$V_{in-out} = \pm 500 V, \text{ See Note 5}$	$10^{11}$			$10^{11}$			$\Omega$		
$C_{io}$	Input-to-output capacitance	$V_{in-out} = 0, f = 1 MHz, \text{ See Note 5}$	1		1.3		1		1.3		pF

NOTE 5: These parameters are measured between both input-diode leads shorted together and all the phototransistor leads shorted together.

switching characteristics at 25°C free-air temperature

PARAMETER	TEST CONDITIONS	TIL189			TIL190			UNIT
		MIN	TYP	MAX	MIN	TYP	MAX	
$t_r$ Rise time	$V_{CC} = 10 V, I_{C(on)} = 10 mA,$	100			100			$\mu s$
$t_f$ Fall time	$R_L = 100 \Omega, \text{ see Figure 1}$	100			100			$\mu s$

**TIL189-1 THRU TIL189-4**  
**TIL190-1 THRU TIL190-4**  
**OPTOCOUPLEDERS/OPTOISOLATORS**

**PARAMETER MEASUREMENT INFORMATION**

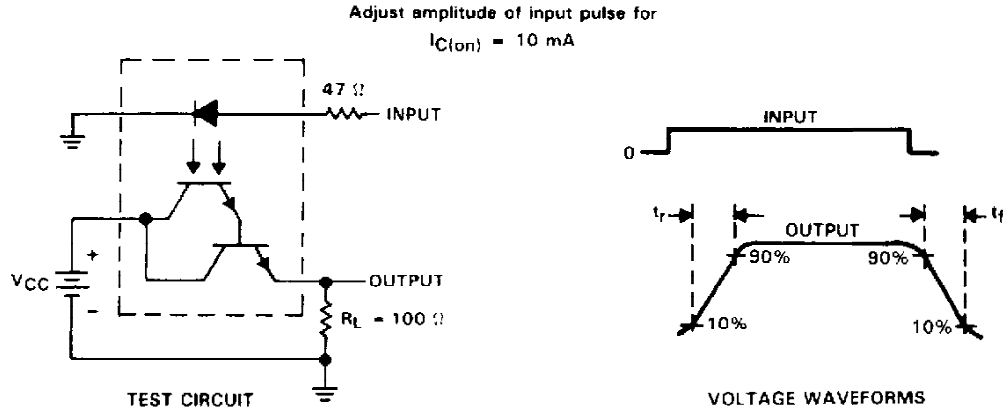

NOTES: A The input waveform is supplied by a generator with the following characteristics:  $Z_0 = 50 \Omega$ ,  $t_r \leq 15 \text{ ns}$ , duty cycle = 1%.  
 B The output waveform is monitored on an oscilloscope with the following characteristics:  $t_f \leq 12 \text{ ns}$ ,  $R_1 \geq 1 \text{ M}\Omega$ ,  $C_{IN} \leq 20 \text{ pF}$ .

**FIGURE 1. SWITCHING TIMES**

**TYPICAL CHARACTERISTICS**

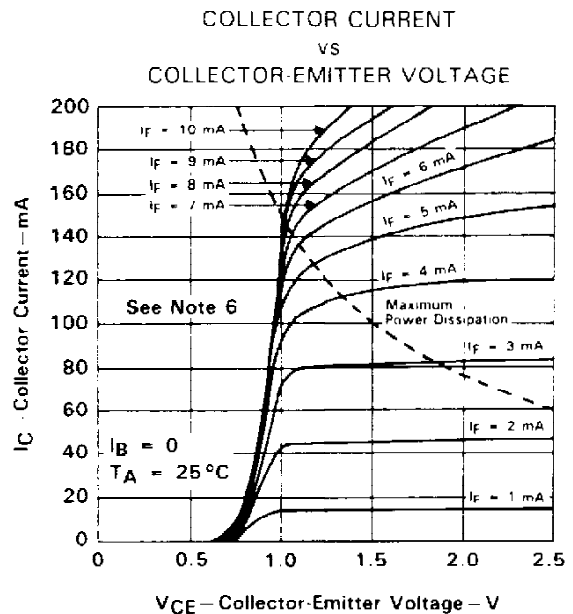
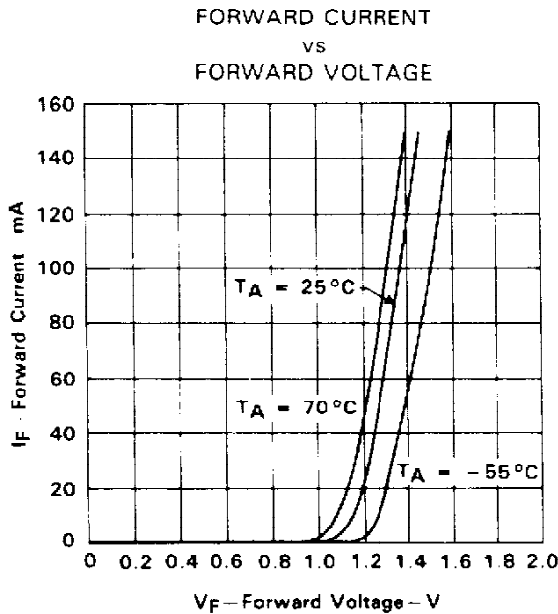

NOTE 6 Pulse operation is required for operation beyond limits shown by the dashed line.

TYPICAL CHARACTERISTICS

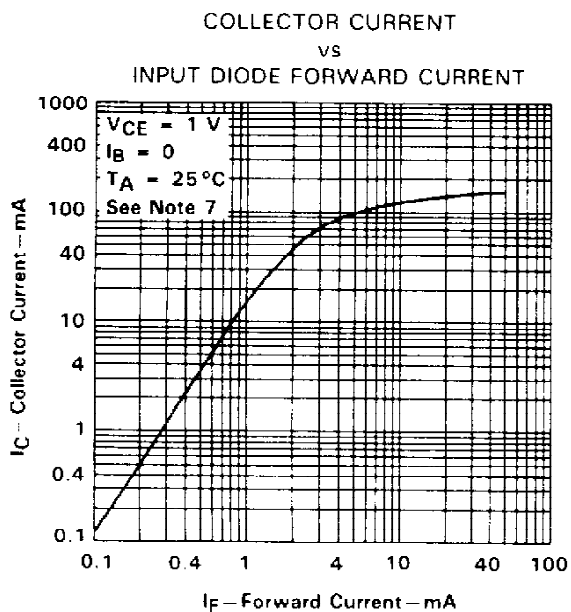

FIGURE 4

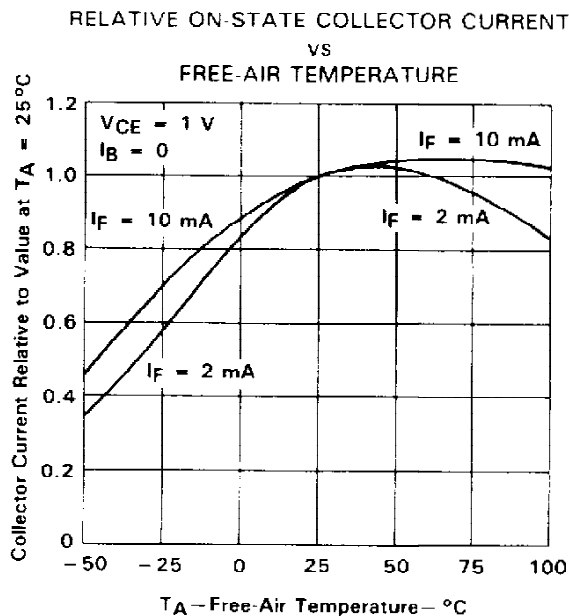

FIGURE 5

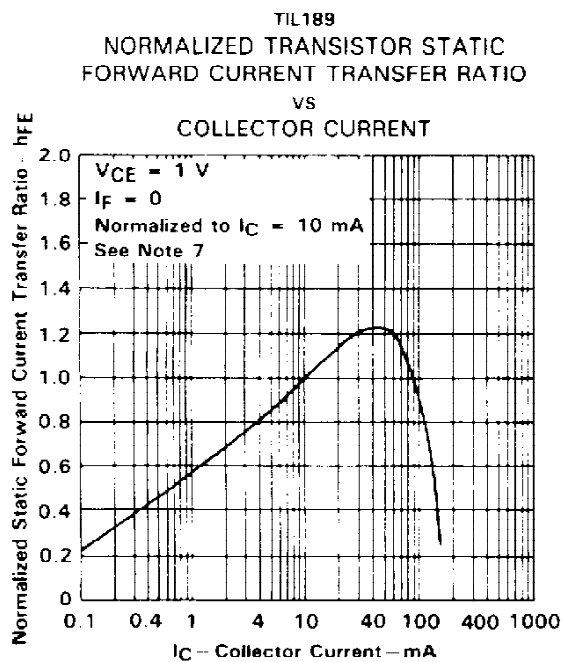

FIGURE 6

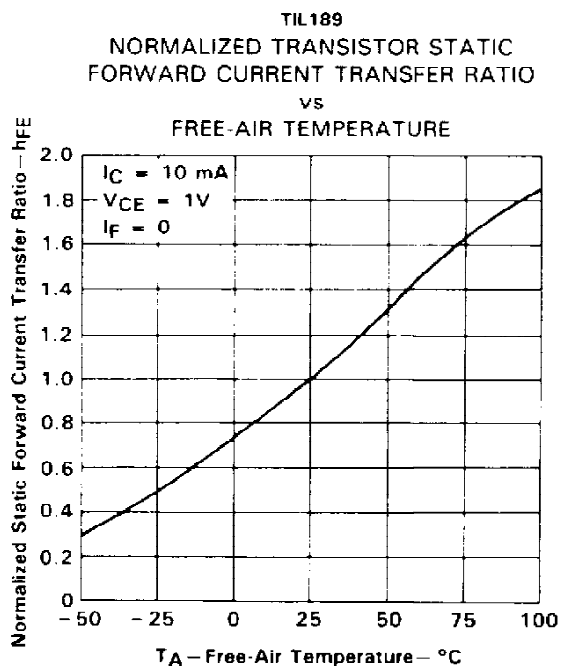
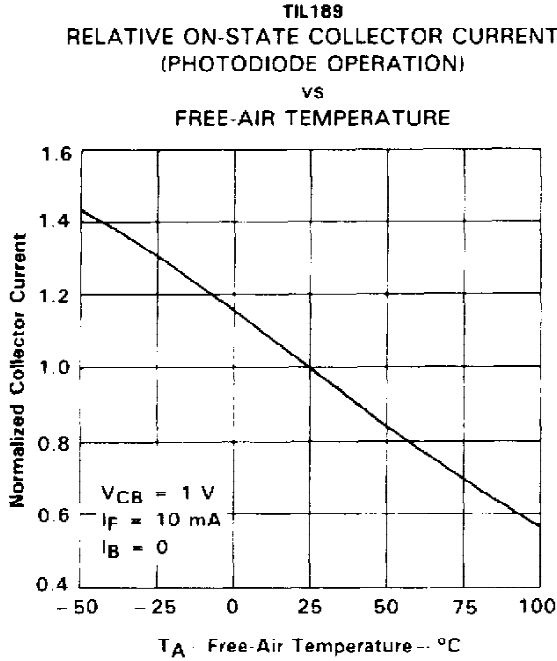

FIGURE 7

NOTE 7: These parameters were measured using pulse techniques  $t_w = 1\text{ ms}$ , duty cycle  $\leq 2\%$ .

**TIL189-1 THRU TIL189-4**  
**TIL190-1 THRU TIL190-4**  
**OPTOCOUPERS/OPTOISOLATORS**

**TYPICAL CHARACTERISTICS**



**FIGURE 8**

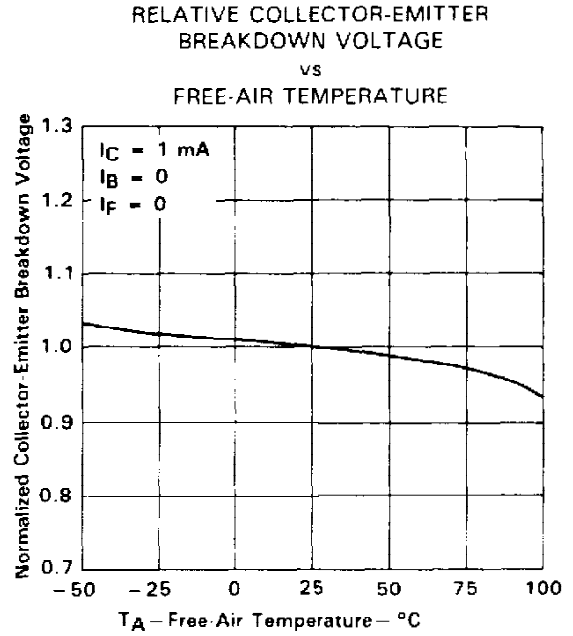

**FIGURE 9**

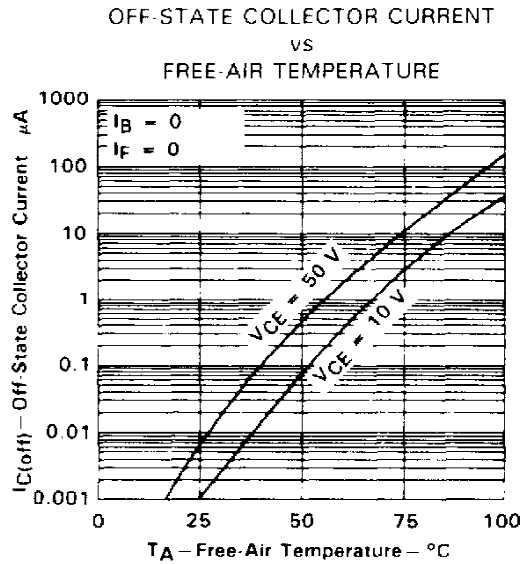

**FIGURE 10**

## IMPORTANT NOTICE

Texas Instruments (TI) reserves the right to make changes to its products or to discontinue any semiconductor product or service without notice, and advises its customers to obtain the latest version of relevant information to verify, before placing orders, that the information being relied on is current.

TI warrants performance of its semiconductor products and related software to the specifications applicable at the time of sale in accordance with TI's standard warranty. Testing and other quality control techniques are utilized to the extent TI deems necessary to support this warranty. Specific testing of all parameters of each device is not necessarily performed, except those mandated by government requirements.

Certain applications using semiconductor products may involve potential risks of death, personal injury, or severe property or environmental damage ("Critical Applications").

TI SEMICONDUCTOR PRODUCTS ARE NOT DESIGNED, INTENDED, AUTHORIZED, OR WARRANTED TO BE SUITABLE FOR USE IN LIFE-SUPPORT APPLICATIONS, DEVICES OR SYSTEMS OR OTHER CRITICAL APPLICATIONS.

Inclusion of TI products in such applications is understood to be fully at the risk of the customer. Use of TI products in such applications requires the written approval of an appropriate TI officer. Questions concerning potential risk applications should be directed to TI through a local SC sales office.

In order to minimize risks associated with the customer's applications, adequate design and operating safeguards should be provided by the customer to minimize inherent or procedural hazards.

TI assumes no liability for applications assistance, customer product design, software performance, or infringement of patents or services described herein. Nor does TI warrant or represent that any license, either express or implied, is granted under any patent right, copyright, mask work right, or other intellectual property right of TI covering or relating to any combination, machine, or process in which such semiconductor products or services might be or are used.